



PARTNER
IN VENTILATION
2VV.CZ

EN

VENESSE SUPERIOR



Installation and operation instructions

1. INSTALLATION

1.1 CONNECTING THE CONTROL

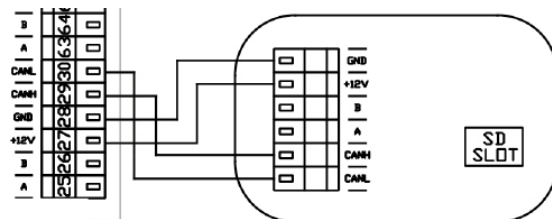
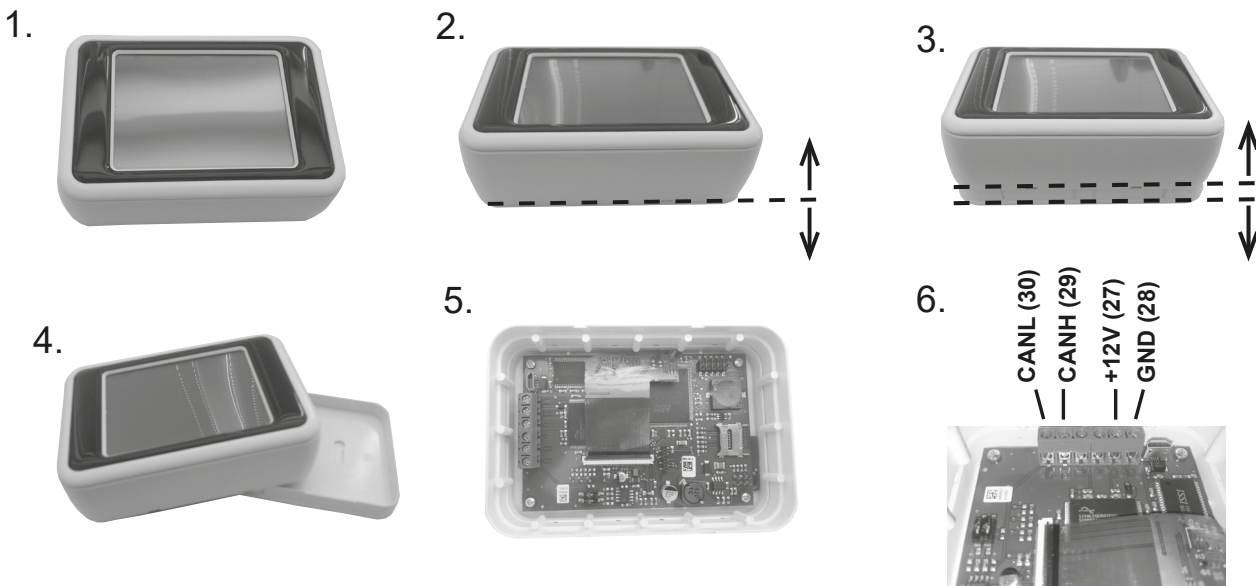
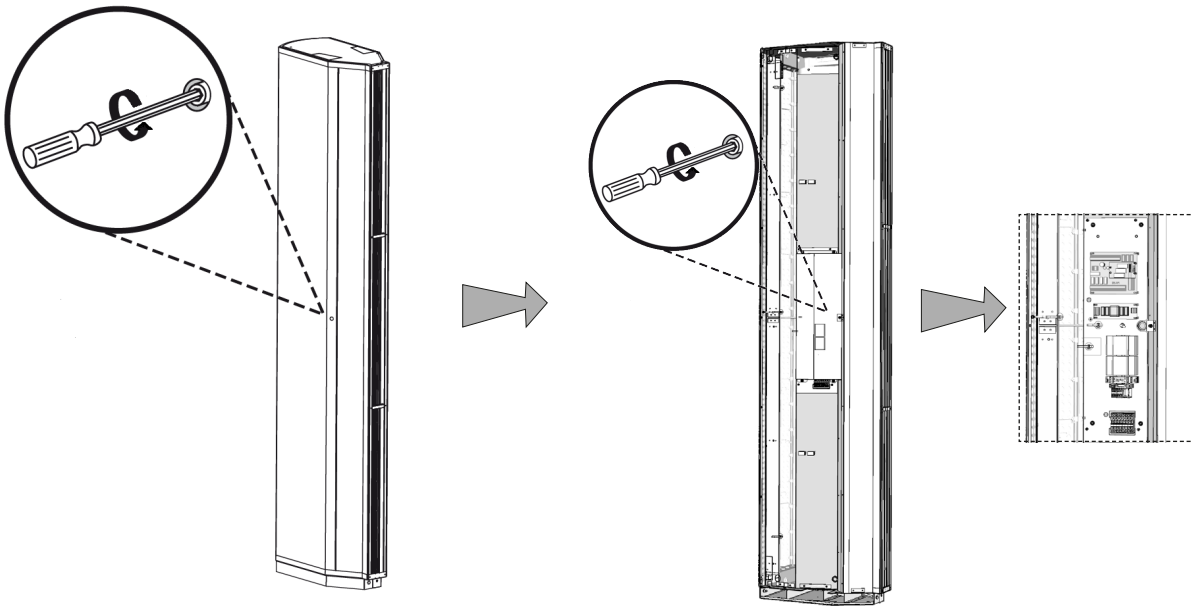

* Recommended UTP CAT5 data cable (twisted pair)

1. INSTALLATION

1.2 EXTERNAL ACCESSORIES

SUPERIOR MASTER
Modul regulace Master Superior

1	Room sensor (included in delivery)
2	LPHW out sensor (included in delivery)
3	Outside air sensor (included in delivery)
4	Signal to SLAVE unit
5	Control panel
6	Antifreeze thermostat (NC)
7	RUN contact (relay contact, NO/NC)
8	ERROR contact (relay contact, NO/NC)
9	Water pump (relay contact)
10	DOOR contact (input, NO/NC)
11	Room thermostat (input, NO/NC)
12	External control (input, NO/NC)
13	Water valve control (0-10V)

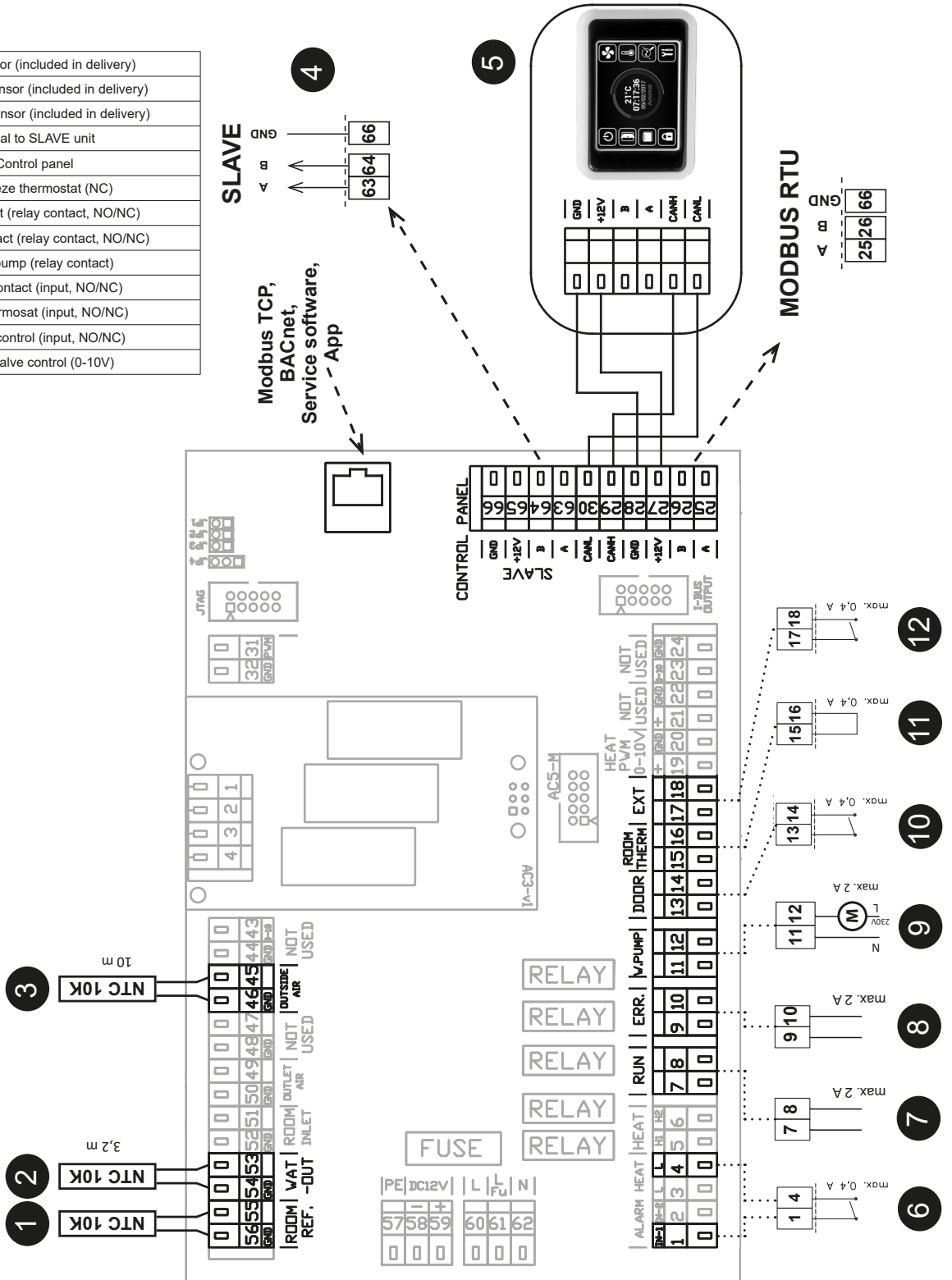
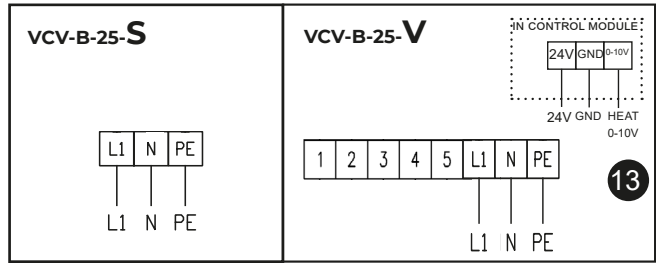

1. INSTALLATION

Regulation module Slave SUPERIOR

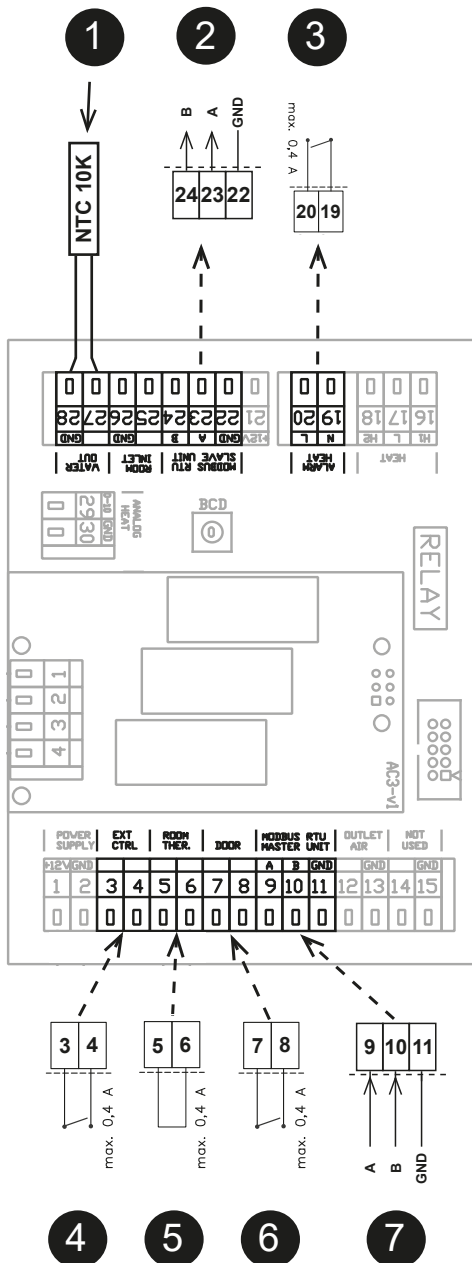
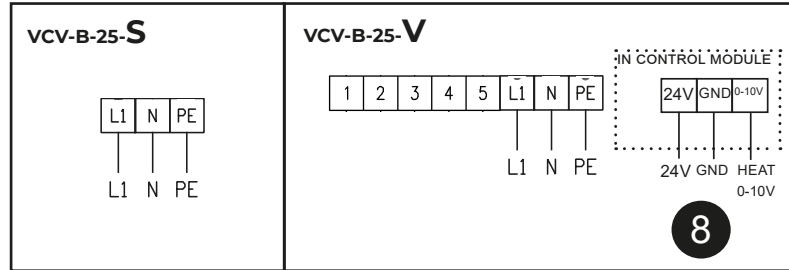

1	LPHW sensor (included)
2	Connection for SLAVE unit
3	Frost Protection (NC)
4	External control - (input, ON / OFF)
5	Thermostat (input, NO / NC)
6	DOOR contact (input, NO / NC)
7	Control signal from MASTER unit
8	24V DC, 0-10 V DC for water valve

1. INSTALLATION

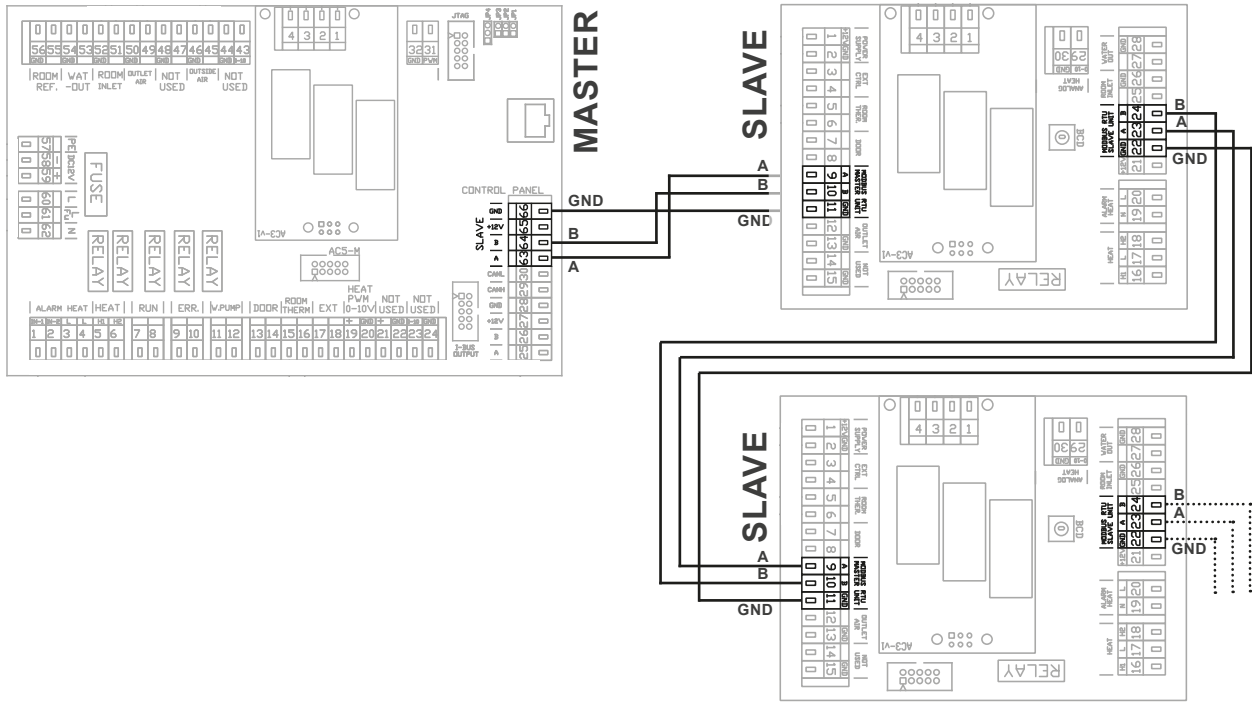
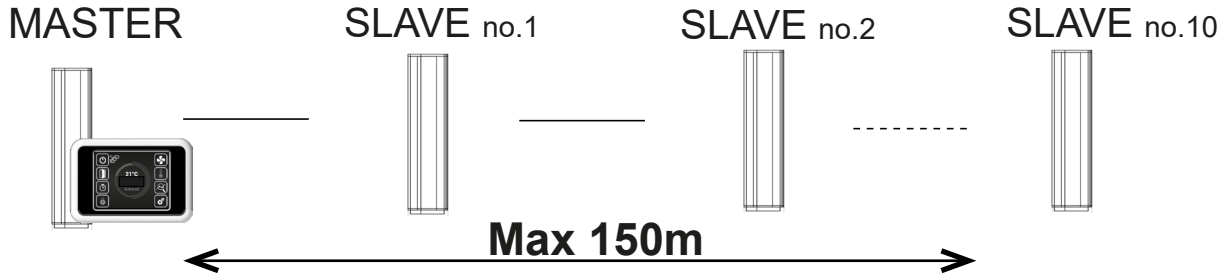

The total bus length of all chained curtains must not exceed 150m!!!

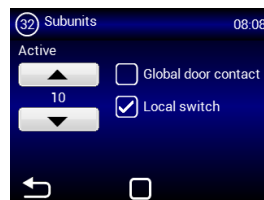
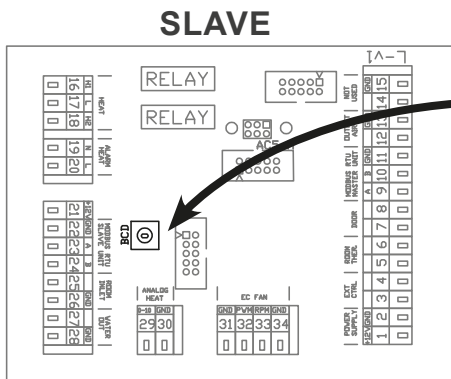

SLA-VE	BCD	SLA-VE	BCD
NO.1	1	NO.6	6
NO.2	2	NO.7	7
NO.3	3	NO.8	8
NO.4	4	NO.9	9
NO.5	5	NO.10	A

1. INSTALLATION

Positions of temperature sensors

Outlet air temperature - already in product

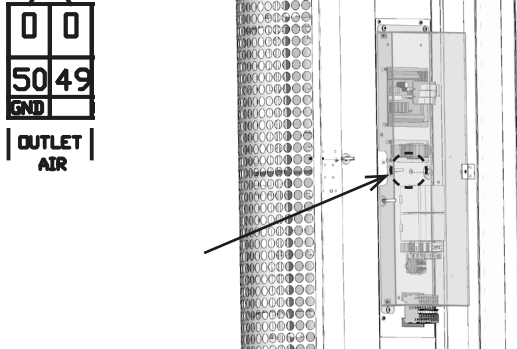

Inlet air temperature - already in product

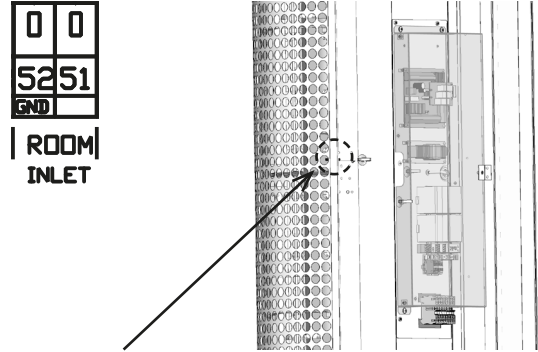

Temperature of return water

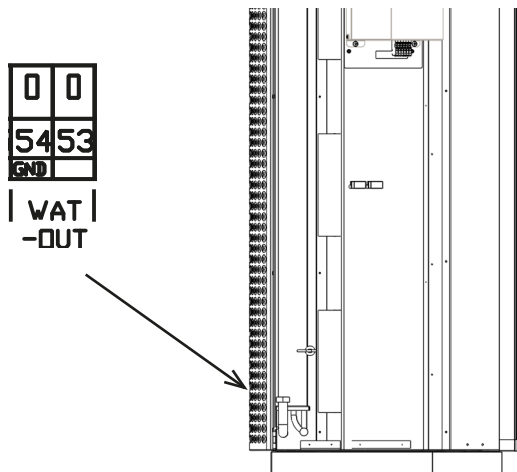

Room temperature sensor - accessories

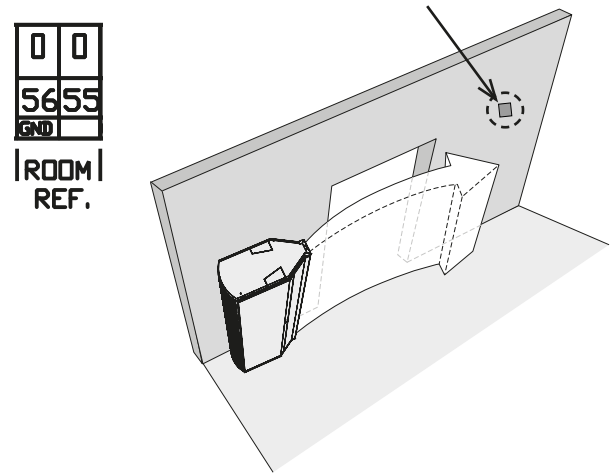

Outside temperature - sensor included

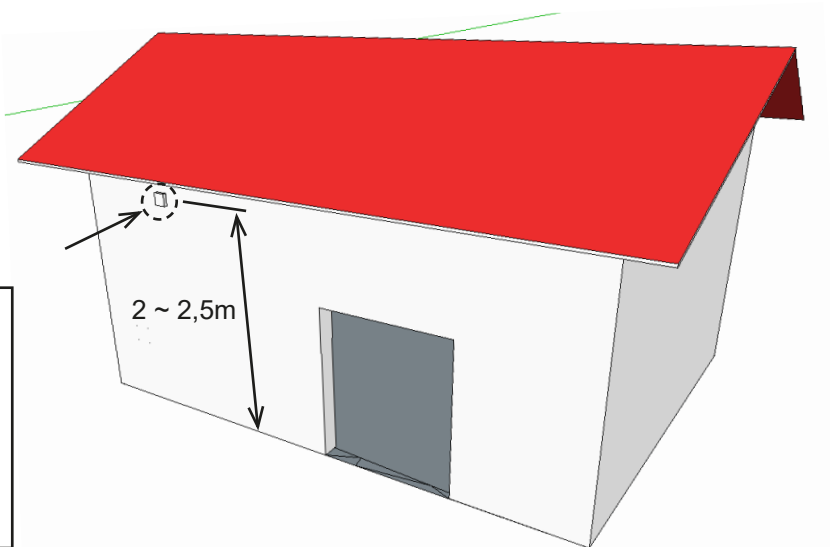

⚠ Outside temperature sensor is recommended to be installed on North side of building, protected against direct sunlight or any other unwanted heat radiation.
 Temperature sensor is recommended to install to an cover box, which should contain small hole for better results. Sensor is water protected.

2. EXTERNAL ACCESSORIES

2.1 CONNECTING EXTERNAL ACCESSORIES



PLEASE NOTE

- The unit must be disconnected from the power supply to connect accessories.
- All external control components must be connected according to the wiring diagram.
- The connectors must be connected to the electrical board with adequate force and always perpendicular to the base.

2.1-1 DS door contact



TECHNICAL INFORMATION

- Isolated switching contact with maximum voltage 230V, 6A
- IP67, can be connected as a break or switching contact



CAUTION!

Not included with the product.

2.1-2 DK-1 / DK-B3 door contact



TECHNICAL INFORMATION

- Isolated switching contact with maximum voltage 12V.
- Cable - Two-core cable with a cross section of 0,5 mm². - Maximum length: 50 m



CAUTION!

Not included with the product.

2.1-3 Thermostatic valve – TV1/1



TECHNICAL INFORMATION

- Thermostatic valve to regulate the water exchanger
- Suitable for all types of curtain with water exchanger
- Works independent to the electronic controls



CAUTION!

Not included with the product.

2.1-4 Zone valve ZV3-24V

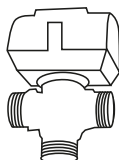

TECHNICAL INFORMATION

- Zone valve to regulate the water exchanger 0-10V
- Cable - Four-core with a cross-section of 0.5 mm² Supply 24 V/ 50/60 Hz, control tension 0-10V



CAUTION!

Not included with the product.

2. EXTERNAL ACCESSORIES

2.1-5 Room thermostat - TER-P

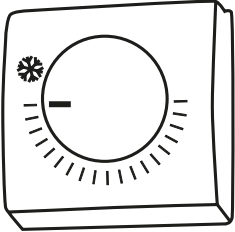

TECHNICAL INFORMATION

- Room thermostat to regulate heating
- Cable - Two-core cable with a cross-section of 1.5 mm², 230 V/ 50 Hz.

 **CAUTION!**

Not included with the product.

3. COMMISSIONING



PLEASE NOTE

Before starting up the unit, check the following:

- Did you leave inside tools or objects that could damage the unit?
- Is the supply of energy and heating water (if applicable) adequate?
- Is the unit well closed?
- Is the control module properly connected?
- Does the unit have adequate protection according to the applicable standards?

4. CONTROL

🔍 READ CAREFULLY!

Before the initial commissioning, check:

- that the device is well fastened to the support structure,
- that the device is properly closed
- that the power supply is properly connected, including the earthing and the external trigger protection,
- that all the electrical components are securely connected,
- that the installation complies with all the instructions herein,
- that no tool or any other object that may damage the unit remains within.

⚠️ CAUTION!

- Interventions or changes to the internal connections are forbidden and shall result in the loss of warranty.
- We recommend the use of accessories supplied by our company. Contact your supplier in case of doubts regarding the use of non-original accessories.

START-UP

After connecting power supply, the display lights up and the data is loaded. The device is ready to be activated once the service data has fully loaded.

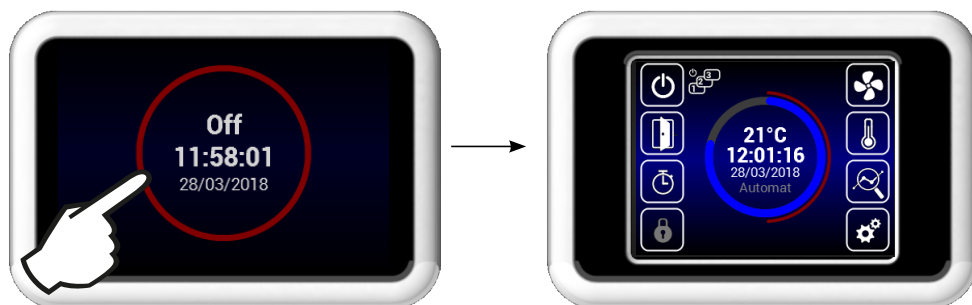

The remote control has a touch screen. The device is controlled tapping the symbols on the screen

Description of main screen

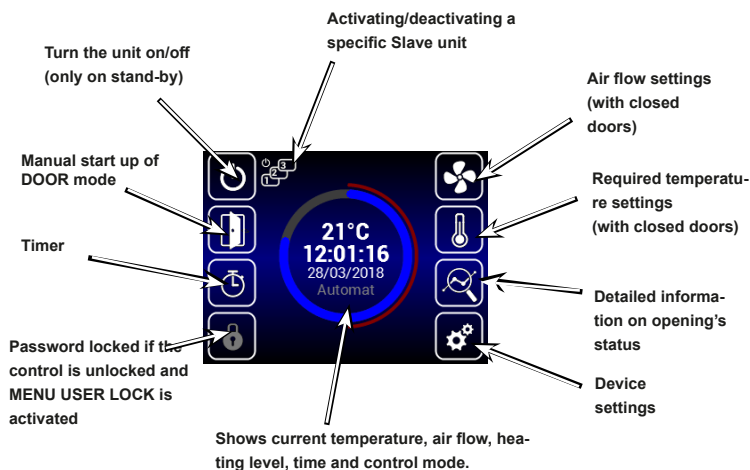

Warning icons

They inform about errors. Clicking on them opens a screen with the error report.

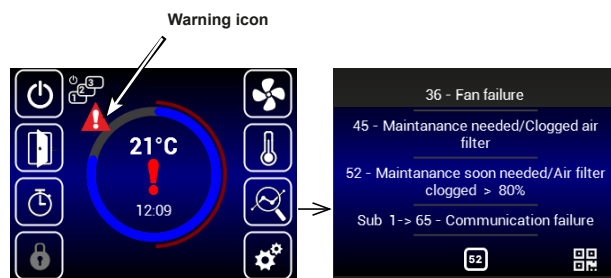

Information icons

They only inform about status, not errors.

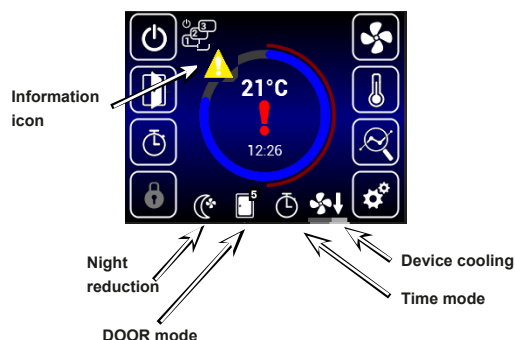

4. CONTROL



Current status

This screen shows the detailed status of the opening and the sensor values:

- Current air-flow settings (step or %), information icons
- Air temperature at intake*, exhaust*, room temperature* and outside temperature* (* – if the relevant sensors are installed and enabled)
- Heater output settings (if included)

Labels for the Current status screen:

- Outside temperature: 16°C
- Inlet temperature: 20°C
- Room temperature: 22°C
- Heat power: 50%
- Fan speed: 80%
- SP= Temperature setpoint: 45°C
- Return water temperature: 18°C
- Green color = active sensor
- Indicates heating is blocked (summer mode)
- Info button
- Back to previous screen button

The information on any connected SLAVE units will be shown here. It can be accessed moving the screen upwards.



Slave units screen showing Sub 3, Sub 4, Sub 5, and Sub 6 with their respective settings and temperatures.

The settings can be found below, under "SUBUNITS"



Settings MENU

Labels for the Settings menu screen:

- Display backlight
- Language
- Date and time
- Timer
- Back to previous screen
- QR code
- Parameters
- Air flow settings (with closed doors)
- Required temperature settings (with closed doors)



Required temperature settings with closed doors

Labels for the Required temperature settings screen:

- Actual temperature at selected sensor in menu 09: 21°C
- Reduce or increase required temperature
- Required output: Manual mode = %, Automatic mode = °C
- Confirm + return

If the heating is blocked in summer mode (MENU - SUMMER HEATING), the screen will show a "Sun" icon and will not allow to select the output.



Air flow settings with closed doors

Labels for the Air flow settings screen:

- Display required air flow (20% steps)
- Display the current air flow status: 80%
- Reduce or increase opening's air flow (with closed doors)
- Confirm + return



Date and time settings

Labels for the Date and time settings screen:

- Current date and time: 08/03/2017 09:05
- Confirm + return
- Back to main screen

4. CONTROL



Timer

Unless otherwise set, the unit goes on stand-by mode after the timer expires.

Activate/deactivate timer

Weekly mode

Annual mode

Confirm + return

Back to main screen

Weekly mode

Tap on a day to set different time modes

Button to copy the day plan to another day

Copy + return

Copy to

Annual mode

START / STOP interval

Start

Stop

14 / 03

24 / 03

0%

0°C

CANCEL

Tap to add a new time mode

Off mode

Only MANUAL

Fan 20%

Required ventilation rate in manual mode

Temperature 0°C

Required heating rate in manual mode



Language

There are 5 languages available

Select language

Confirm + return

Back to main screen

Confirmation of selection



Lightning settings

On mode

Standby

Lightning level on stand-by

Display backlight when on

Confirm + return

Back to main screen

4. CONTROL

AirGENIO App



QR code for downloading the AirGENIO application for smart devices

Pairing mobile device with unit using QR code.

Pairing smart device:

The IP address and PIN of the unit can be entered manually or by using a QR code for quick pairing of the unit.

1. Pairing using QR code:

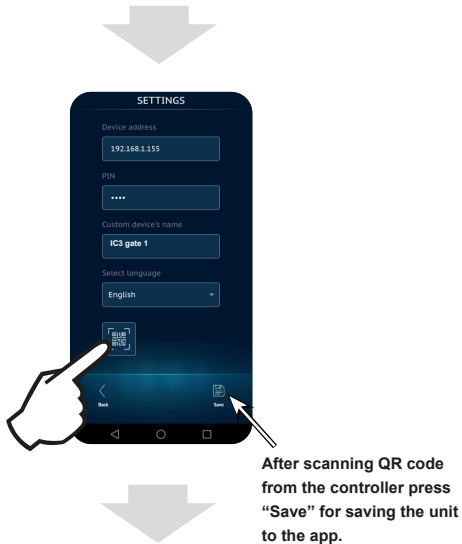

2. Manual pairing:

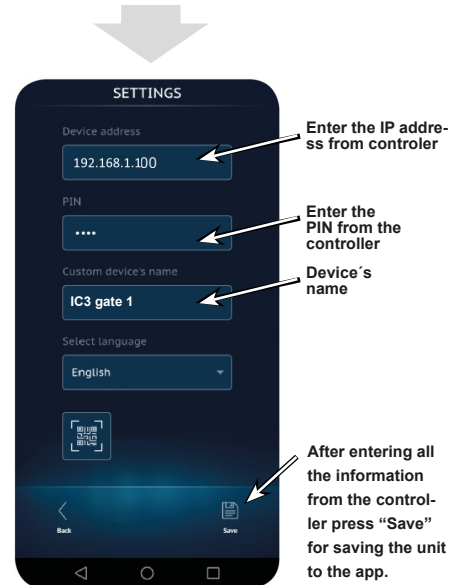
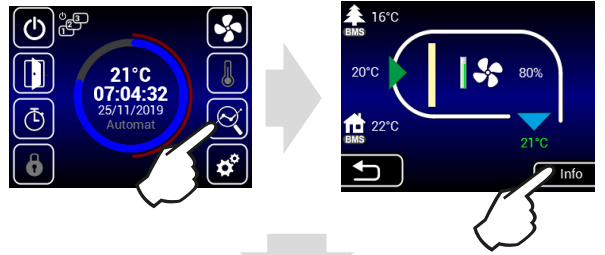

4. CONTROL



Service menu

Enter code 1616 to access the service menu

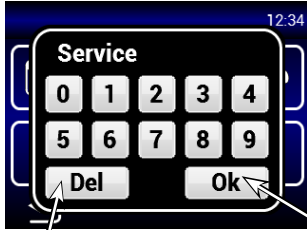

1616

Delete/return

Access menu



Choose this menu after centring the screen and tapping on enter.

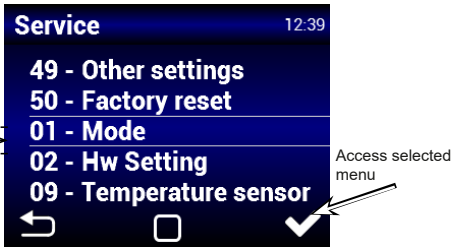

Access selected menu

MENU - MODE

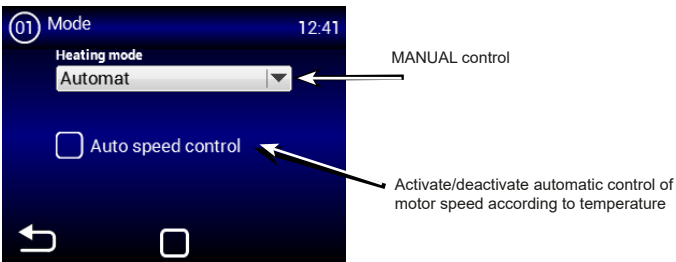

MANUAL control

Activate/deactivate automatic control of motor speed according to temperature

Setting AUTO or MANUAL may block/unblock certain items in the service menu.

MENU - HW SETTING



Use this menu to set the detailed behaviour of the inputs and outputs of the regulators

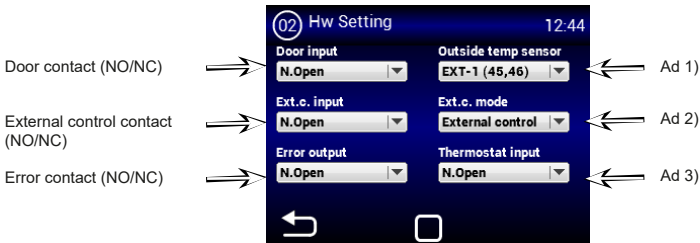

Ad 1) - External temperature sensor activation/settings Options:
None - no sensor connected - inactive
EXT-1 (45,46) - sensor connected (must be on terminals 45 y 46)
BMS - sensor active and used from the master system

Ad 2) - Sets the external contact input behaviour. Options:
None - inactive
External control - External switching of device
Night reduction - Night reduction on/off (settings described below)

Ad 3) - Thermostat (NO/NC)

MENU - FILTER TIMER



Use this menu to set the period (in motor hours) after which you will be reminded to replace the filters or reset to timer.



Set the time after which a notice will appear in the main screen.

1000h ~ 5000h

Current timer status

RESET button (use after replacing filters)

Shows the status of the clogged filter in the main screen

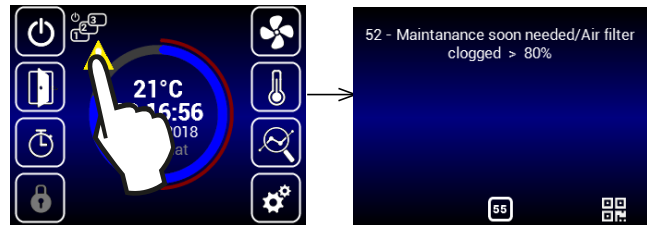

MENU - TEMPERATURE SENSOR



Available only in automatic mode

Use this menu to select the sensor to be used for primary temperature control

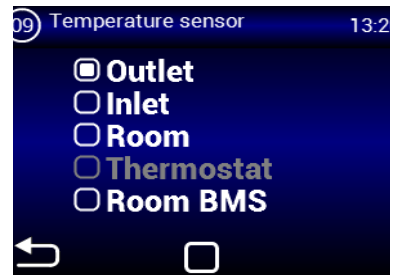

Only available in Manual mode.

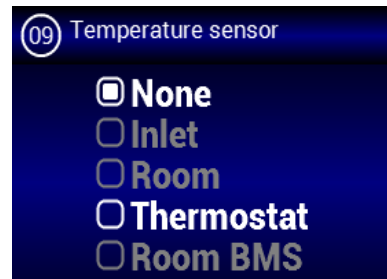

Options:

- Outlet** - Temperature sensor at the outlet (behind the exchanger)
- Inlet** - Temperature sensor at the inlet (before the exchanger)
- Room** - Room temperature sensor
- Thermostat** - Room thermostat (ON/OFF)
- Room BMS** - Room temperature sensor from master system

4. CONTROL

MENU - OUTLET TEMP LIMITS

Use this menu to set the limits of the exhaust

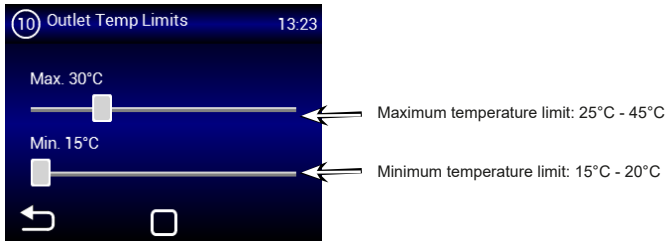

If "OUTLET" is selected in the TEMPERATURE SENSOR MENU, it will not be possible to set values as they are already defined by the sensor. You will see this screen:

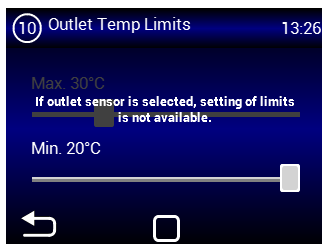

MENU - MODBUS RTU

Use this menu to set the Modbus RTU communication parameters



An incorrect setting may prevent communication with the regulator

MENU - NETWORK

Use this menu to set the communication parameters of the network interface

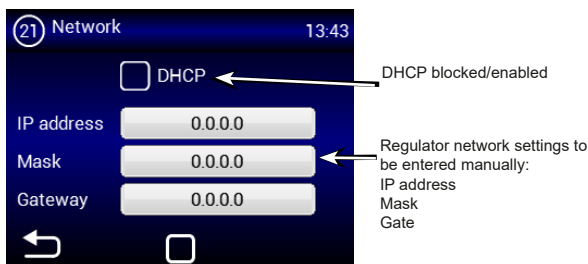

An incorrect setting may prevent communication with the regulator

MENU - USER LOCK

Use this menu to set the limits to control the regulator with a multi-level panel

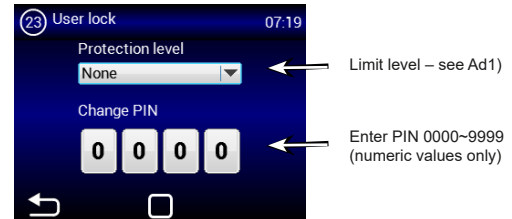

Options:

None – Limit inactive

On/Off – Only On/Off and access to the information menu are enabled in the main screen

On/Off, Temp, Flow – On/Off, the information menu, and temperature and air flow settings can be accessed without password.

Full – Only the information menu can be accessed without password

User mode – Special user mode, see image below

MENU - SUMMER HEATING

Use this menu to set heating limits in summer months

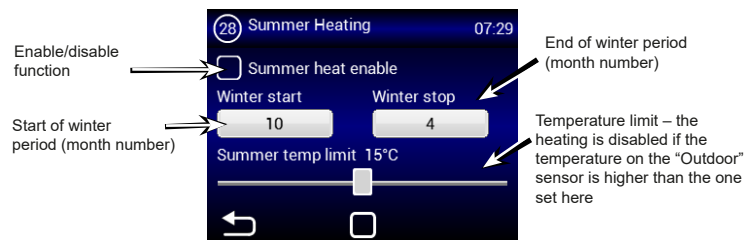

If the outside temperature sensor is not set, the "summer heating" mode will operate only according to the selected time and the temperature will not be taken into account

MENU - Night Reduction

This MENU allows for setting reduced temperatures during night hours with closed doors.

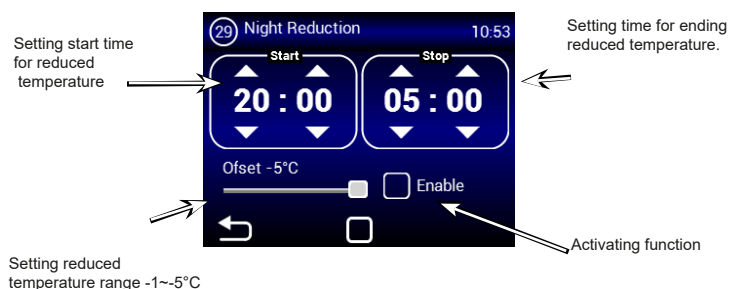

In this menu, the reduction of temperature may be set only by five degrees at the set time compared to the set (required) temperature.

4. CONTROL

MENU - DOOR CONTACT

 This MENU allows for setting the behaviour of the regulator according to doors contact

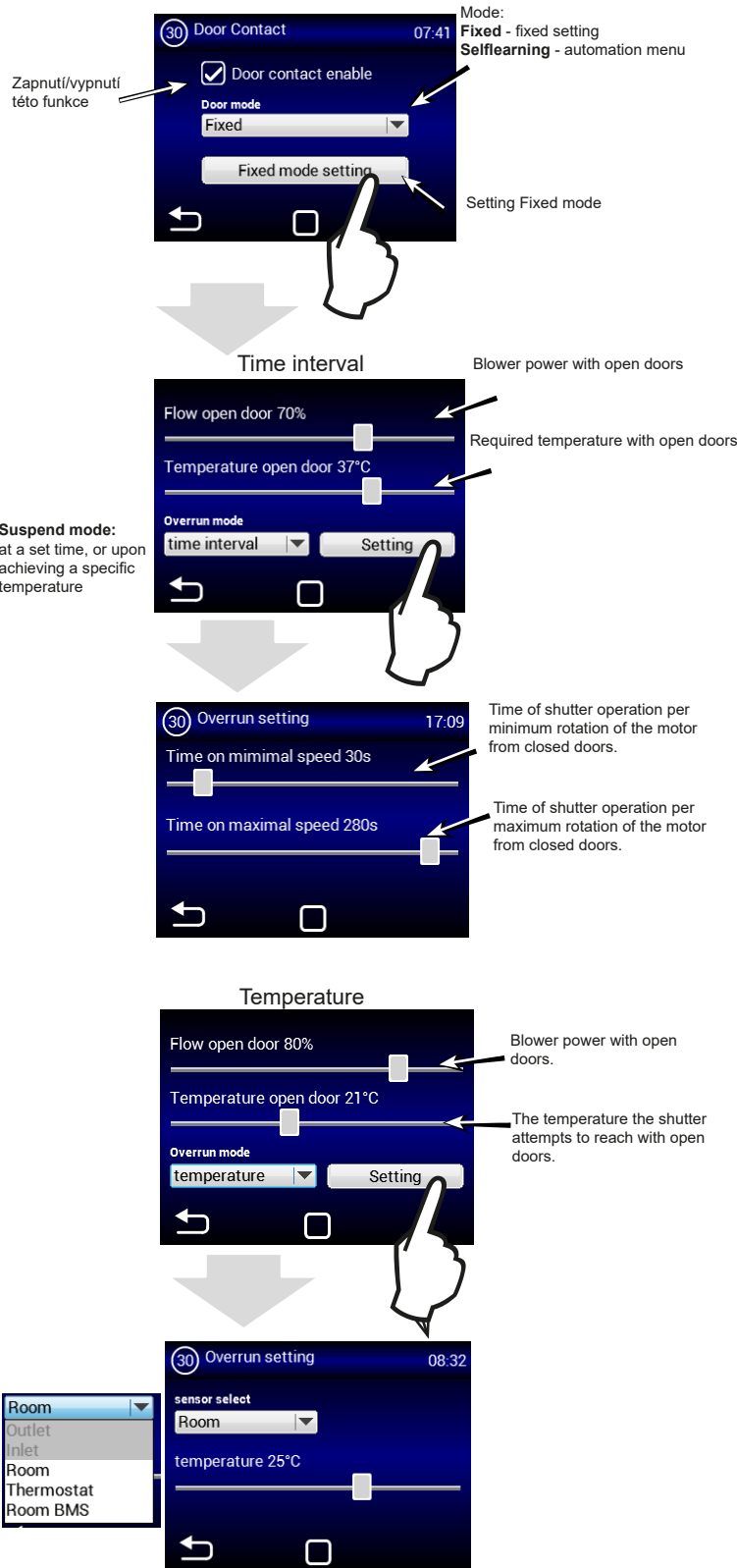

Zapnutí/vypnutí této funkce

Mode:
Fixed - fixed setting
Selflearning - automation menu

Setting Fixed mode

Time interval

Blower power with open doors

Required temperature with open doors

Suspend mode:
at a set time, or upon achieving a specific temperature

Time of shutter operation per minimum rotation of the motor from closed doors.

Time of shutter operation per maximum rotation of the motor from closed doors.

Temperature

Blower power with open doors.

The temperature the shutter attempts to reach with open doors.

Room
Outlet
Inlet
Room
Thermostat
Room BMS

In this menu it is possible to specify which sensor will be active and the temperature the shutter will attempt to reach after closing doors so as to balance temperature loss. After reaching the set temperature, the shutter transitions into the selected automatic/manual mode.

MENU - DOOR CONTACT

MENU Selflearning



Selflearning- available only in automation and active function mode (Auto speed control), depending on the number of open doors it optimises the period in which the shutter is in operation, even when doors are closed.

Must be set to activate Selflearning.

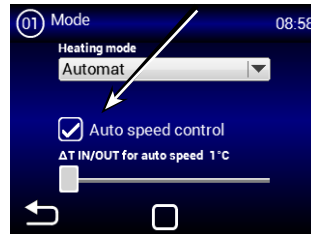

MENU - WATER ANTIFREEZE

The menu is enabled only in units with water exchanger

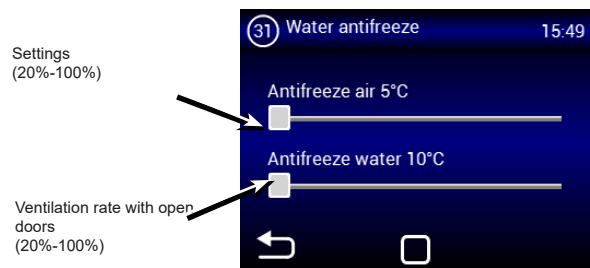

Settings (20%-100%)

Ventilation rate with open doors (20%-100%)

4. CONTROL

MENU - SUBUNITS

Use this menu to set the behaviour of the IC-S regulators connected as SLAVE



Number of SLAVE regulators: 0 ~ 10

Slave address parameter:

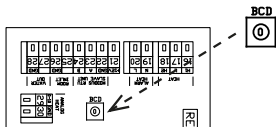

ADDRESS	SLAVE UNIT	ADDRESS	SLAVE UNIT
1	1	6	6
2	2	7	7
3	3	8	8
4	4	9	9
5	5	A	10

Ad 1) – Use one door contact as main. Its status will be sent to the SLAVE regulators and it will no longer be necessary to connect it to each regulator, if required.

- Not allowed = the door contact will not transmit to the SLAVE regulator from the MASTER
- Allowed = the door contact will transmit to the SLAVE regulator from the MASTER

Ad 2) – Activates in the main screen the icon to turn each SLAVE regulator ON/OFF. If inactive, all the SLAVE regulators will be turned on or off simultaneously

- Not allowed = The SLAVE regulators are turned on/off simultaneously
- Allowed = The SLAVE regulators can be turned on/off individually from the main screen

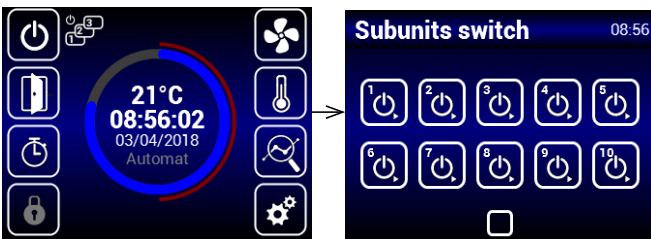

MENU - Adv. WATER SETTING



This MENU is available only for units with water heat exchanger it allows for advanced setting of water heat exchanger regulation.

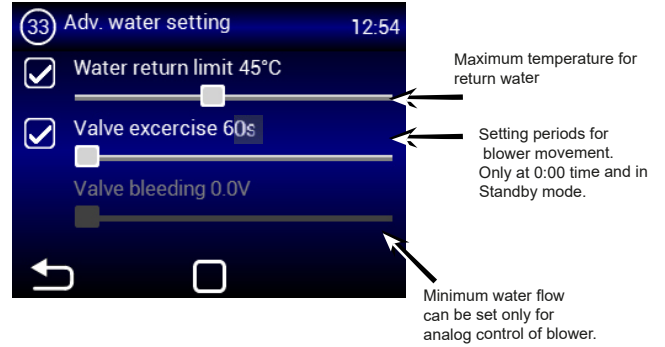

Maximum temperature for return water

Setting periods for blower movement. Only at 0:00 time and in Standby mode.

Minimum water flow can be set only for analog control of blower.

MENU - Adv. fan setting

The MENU for setting the blowers when closing and opening doors. It allows for advanced settings of blower control.

The time for which the blower will be operational from the moment the desired temperature is achieved +0.3°C on the ROOM sensor in closed door mode. This setting is available only when the ROOM regulation sensor is selected (1616/Temperature sensor)

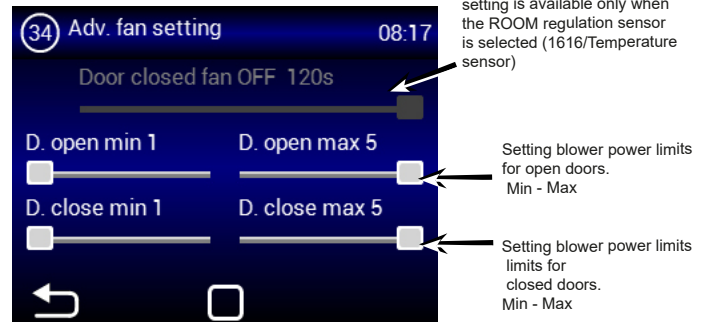

Setting blower power limits for open doors. Min - Max

Setting blower power limits for closed doors. Min - Max



The set limits on blower power restrict the extent of blower control for open and closed doors. This restriction is applied to manual and automatic control of blower power. Exceeding limits in any blower power setting is signalled when the setting element turns red with the text overruns.

4. CONTROL

MENU - OTHER SETTINGS

Use this menu to set the remaining parameters

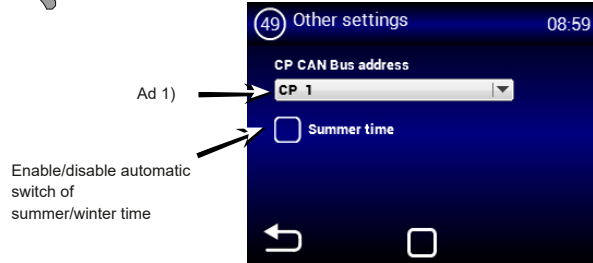

Ad 1) – Sets the CAN address of the control panel so up to 2 control panels may be connected to the MASTER regulator
 Options: CP 1 = control panel's address is 1
 CP 2 = control panel's address is 2

The address is set for each control, which then addressed according to it.

CAUTION!

Each panel must have its own address, otherwise it may result in the malfunction of the regulator.

Terminals must be set if multiple panels are to be connected. They are found in the main electronics and the controller:

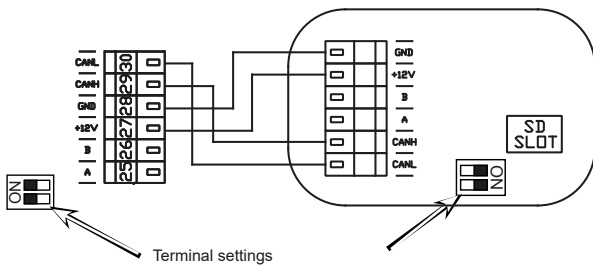

Example of controller connection – Option 1:

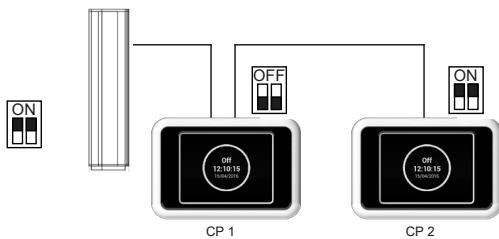

Electric connection – Option 1:

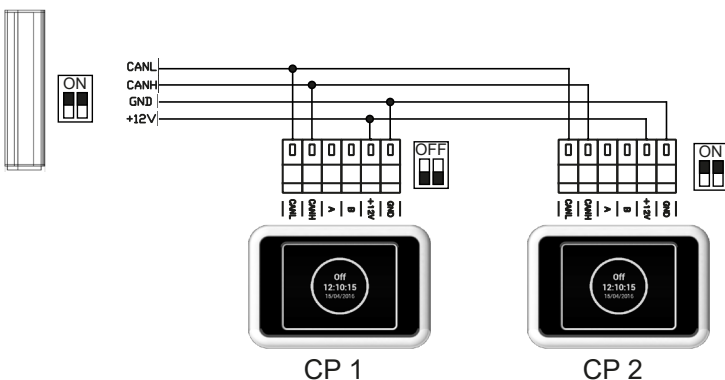

Electric connection – Option 2:

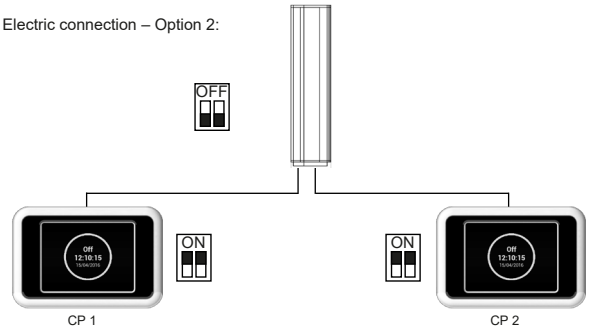

Electric connection – Option 2:

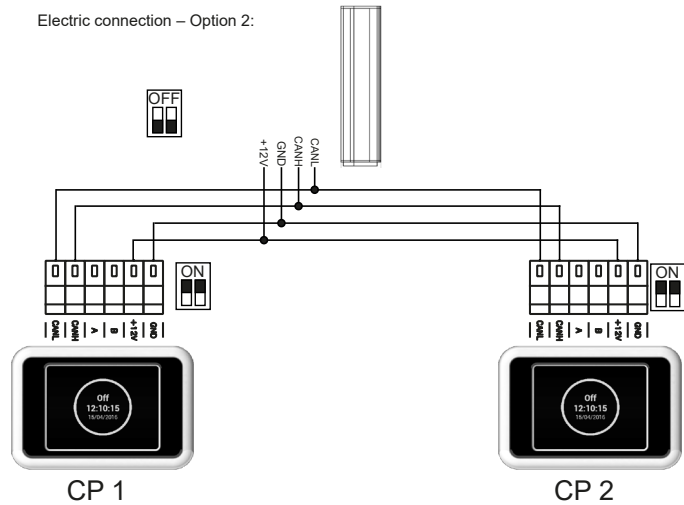

MENU - FACTORY RESET

Use this to reset the default values



Press "FACTORY RESET" to reset the default values of MENU 1616



Once completed, we recommend to turn the main supply off and on.

5. MALFUNCTIONS

5.1 MALFUNCTIONS

Disconnect the main power supply before any intervention to the unit. If you are not sure of the correct steps, do not attempt to perform any repairs and call a professional service!

Description	Unit behaviour	Likely problem	Solution
44 – Fan error	Unit out of order	Overheated fan or defect on thermal contact of inlet fan	Determine the cause of the overheating (defective bearing, short-circuit...) or replace the motor. Check the thermal contacts from the motor to the regulator.
45 – Mandatory maintenance/filter clogged	Unit operational	Filter clogged or the time to replace it has come	Replace filters. After replacing, do not forget to reset the MENU 1616 – FILTER TIMER
46 – Heater malfunction	Unit out of order	Heater malfunction	Check the heater and the condition of the safety thermostat Does the heater have proper cooling? Check engine running.
47 - malfunction in external temperature sensor (45,46)	Unit out of order	Temperature sensor malfunction on terminals 45,46	Check that the sensor is correctly connected to the electronics or test it measuring its resistance (the resistance value at +20°C is around 10kΩ)
48 – Outlet temperature sensor malfunction (49,50)	Unit out of order	Temperature sensor malfunction on terminals 49,50	Check that the sensor is correctly connected to the electronics or test it measuring its resistance (the resistance value at +20°C is around 10kΩ)
49 – Inlet temperature sensor malfunction (51,52)	Unit out of order	Temperature sensor malfunction on terminals 51,52	Check that the sensor is correctly connected to the electronics or test it measuring its resistance (the resistance value at +20°C is around 10kΩ)
60 – Exchanger's return sensor malfunction (53,54)	Unit out of order	Temperature sensor malfunction on terminals 53,54	Check that the sensor is correctly connected to the electronics or test it measuring its resistance (the resistance value at +20°C is around 10kΩ)
61 – Room temperature sensor malfunction (55,56)	Unit out of order	Temperature sensor malfunction on terminals 55,56	Check that the sensor is correctly connected to the electronics or test it measuring its resistance (the resistance value at +20°C is around 10kΩ)
62 - malfunction in external temperature sensor from BMS	Limited operation of the device	Temperature sensor malfunction in BMS	Check that in the BMS that the address where the sensors sends the data is properly set (on the right regulator) Check the function of the sensor in the BMS
63 - malfunction in room temperature sensor from BMS	Limited operation of the device	Temperature sensor malfunction in BMS	Check that in the BMS that the address where the sensors sends the data is properly set (on the right regulator) Check the function of the sensor in the BMS
79 – Heating reduced due to low air flow	Unit operational	Only information	The air flow settings were reduced, limiting the heater output to prevent overheating
65 – Communication error	Unit out of order	Communication error	Check the communication cable for damages and if it is properly connected Observe the wiring diagram to prevent occurrences that may disrupt communication (wiring near high tension, phenomena on site causing disruptions)
Unit's not working	Unit out of order	Power supply interrupted	Check that the power supply is not interrupted
		Cracked fuse	Check the fuse in side the control module
The heating switches off automatically	Unit operational but not heating	The heater overheats	The heater overheats due to insufficient air flow. Check that the ventilators are in good order and that the air supply is not disrupted.

6. MAINTENANCE

6.1 CLEANING

CAUTION!

- Do not use compressed air, chemicals, solvents or water to clean the unit.
- Use a soft brush or a vacuum cleaner to clean the suction cover and the inside of the unit.
- See the installation manual of the ESSENSSE NEO curtain

7. SERVICE

7.1 IF YOU ARE UNABLE TO REPAIR THE UNIT

If you were unable to solve a problem, contact the supplier or the representative of 2VV. Warranty and post-warranty service are provided by the supplier or an authorised service included in the list available at the supplier's.

Give the following information to the supplier or service:

- **type designation of the air curtain**
- **accessories in use**
- **place of installation**
- **serial number**
- **conditions of the installation (incl. electrical)**
- **period of operation**
- **detailed description of the malfunction**

7.2 – DECOMMISSIONING THE PRODUCT – LIQUIDATION

Before scrapping the product, make it unusable. Old products still have raw materials that can be reused. Take them to a collection centre for secondary raw materials. It is preferable to have the product liquidated by a specialist so that the recyclable materials may be reused. Take the unusable parts to an appropriate waste disposal site.



The liquidation of materials must observe the applicable waste management regulations.

8. CONCLUSION

8. CONCLUSION

In case of any doubt or query, do not hesitate to contact our sales or technical support departments.

CONTACT

Address:

2VV, s.r.o.,
Fáblůvka 568,
533 52 Pardubice,
Česká republika

Internet :

<http://www.2vv.cz/>

